



PNEUMATIC ACTUATED BALL VALVE (DOUBLE ACTION TYPE)



CO Series

雙式氣動球閥

SOCKET CO100 / THREAD CO200 / FLANGED CO300
Size: 1/2"-4"

MATERIALS OF CONSTRUCTION

No.	Parts	Pcs	Materials	No.	Parts	Pcs	Materials
1	STEM	1	UPVC, PP, CPVC, PVDF	9	BODY O-RING	2	EPDM, VITON
2	BALL	1	UPVC, PP, CPVC, PVDF	10	SEAT CARRIER	1	UPVC, PP, CPVC, PVDF
3	BODY	1	UPVC, PP, CPVC, PVDF	11	BRASS INSERTS	4...15-50 8...65-100	BRASS
4	UNION NUT	2	UPVC, PP, CPVC, PVDF	12	FLANGE	2	UPVC, PP, CPVC, PVDF
5	END CONNECTOR	2	UPVC, PP, CPVC, PVDF	13	MOUNTING BRACKET	1	SU304
6	SEAT	2	PTFE	14	STEM TRANSMIT HOUSING	1	SU304
7	STEM O-RING	1.15-50 2..65-100	EPDM,VITON	15	PNEUMATIC ACTUATORS	1	ECRLD ALLIMINUM ALLOY
8	SEAT CARRIER O-RING	1	EPDM,VITON				

* 氣缸動作壓力(氣壓)：最小5kg/cm²
最大8kg/m²

DIMENSIONS TABLE

JIS																				Unit: mm		
Nominal Pipe Size	D1	D2	D3	d			e	n	P	L			H	H1	A	J	T	K	E	S	S1	Working press (kgf/cm ²)
				Socket	Thread					Socket	Thread	Flange										
15(1/2")	15	70	95	22	PT1/2"	15	4	22.2	115	115	152	151.6	40	137	66	15	31			3/16"-24G	4	10
20(3/4")	19	75	100	26	PT3/4"	15	4	25.4	128	128	163	157.5	40	137	66	15	37			1/4"-20G	4	10
25(1")	25	90	125	32	PT 1"	19	4	28.6	144	144	187	162.0	40	137	66	17	40			1/4"-20G	4	10
32(1-1/4")	38	100	135	38	PT1-1/4"	19	4	31.8	183	183	225	197.7	55	152	73	17	55			5/16"-18G	4	10
40(1-1/2")	38	105	140	48	PT1-1/2"	19	4	34.9	183	183	232	197.7	55	152	73	19	55			5/16"-18G	4	10
50(2")	48	120	155	60	PT 2"	19	4	38.1	202	202	253	208.3	55	152	85	21	68			5/16"-18G	4	10
65(2-1/2")	65	140	175	76	PT2-1/2"	19	4	44.5	228	228	282	263.2	68	230	98	21	80	41		5/16"-18G	8	7
80(3")	78	150	185	89	PT 3"	19	8	47.6	270	270	327	307.7	85	271	110	22	80	41		5/16"-18G	8	7
100(4")	102	175	210	114	PT 4"	19	8	57.2	324	324	385	326.0	80	360	140	22	121	50		5/16"-18G	8	7

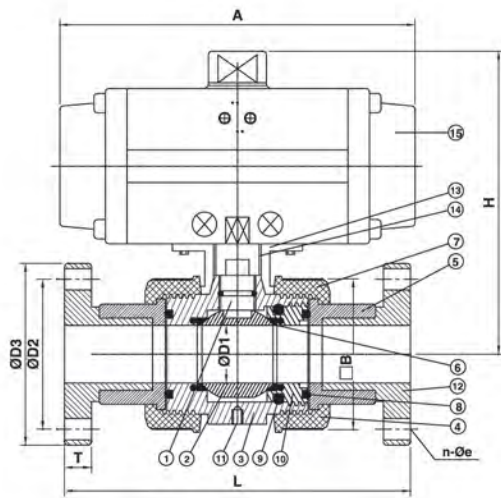

DN15-DN100
FLANGE TYPE

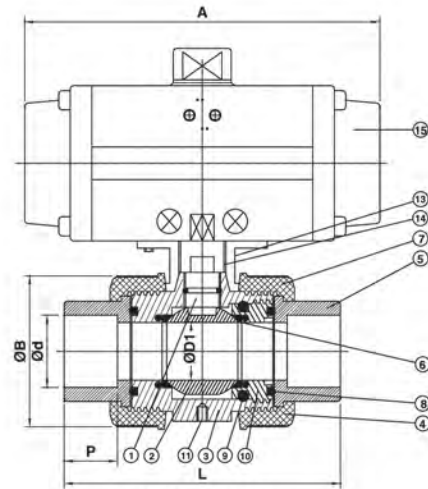

DN15~DN1000
SOCKET & SCREW TYPE

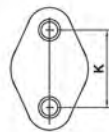

DN15-DN50

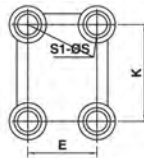

DN65-DN100

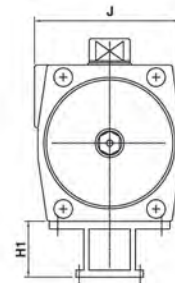

MOUNTING PAD

DIMENSIONS TABLE

ANSI																		Unit: inch			
Nominal Pipe Size	D1	D2	D3	d		e	n	P	L			H	H1	A	J	T	K	E	S	S1	Working press (lb/in ²)
				Socket	Thread				Socket	Thread	Flange										
15(1/2")	0.59	2.375	3.500	0.848	PT1/2"	0.625	4	0.875	4.527	4.527	5.984	5.97	1.57	5.39	2.60	0.59	1.22		3/16"-24G	4	148
20(3/4")	0.748	2.750	3.875	1.058	PT3/4"	0.625	4	1.000	5.039	5.039	6.417	6.20	1.57	5.39	2.60	0.59	1.45		1/4"-20G	4	148
25(1")	0.98	3.125	4.250	1.325	PT 1"	0.625	4	1.125	5.669	5.669	7.36	6.38	1.57	5.39	2.60	0.66	1.57		1/4"-20G	4	148
32(1-1/4")	1.496	3.500	4.625	1.670	PT1-1/4"	0.625	4	1.125	7.204	7.204	8.858	7.78	2.17	5.98	2.87	0.66	2.16		5/16"-18G	4	148
40(1-1/2")	1.496	3.875	5.000	1.912	PT1-1/2"	0.625	4	1.375	7.204	7.204	9.133	7.78	2.17	5.98	2.87	0.75	2.16		5/16"-18G	4	100
50(2")	1.89	4.750	6.000	2.387	PT 2"	0.750	4	1.500	7.952	7.952	9.960	8.20	2.17	5.98	2.87	0.83	2.67		5/16"-18G	4	100
65(2-1/2")	2.56	5.500	7.000	2.889	PT2-1/2"	0.750	4	1.750	8.976	8.976	11.102	10.36	2.68	9.06	3.86	0.83	3.15	1.61	5/16"-18G	8	100
80(3")	3.07	6.000	7.500	3.515	PT 3"	0.750	4	1.875	10.629	10.629	12.992	12.11	3.35	10.76	4.33	0.866	3.15	1.61	5/16"-18G	8	100
100(4")	4.01	7.500	9.000	4.518	PT 4"	0.750	8	2.250	12.755	12.755	15.157	12.83	3.15	14.17	6.10	0.866	4.76	1.97	5/16"-18G	8	100

DIN																		Unit: mm			
Nominal Pipe Size	D1	D2	D3	d		e	n	P	L			H	H1	A	J	T	K	E	S	S1	Working press (kgf/cm ²)
				Socket	Thread				Socket	Thread	Flange										
15(1/2")	15	65	95	20	PT1/2"	14	4	16.0	115	115	152	151.6	40	137	66	15	31		3/16"-24G	4	10
20(3/4")	19	75	105	25	PT3/4"	14	4	18.5	128	128	163	157.5	40	137	66	15	37		1/4"-20G	4	10
25(1")	25	85	115	32	PT 1"	14	4	22.0	144	144	187	162.0	40	137	66	17	40		1/4"-20G	4	10
32(1-1/4")	38	100	140	40	PT1-1/4"	18	4	26.0	183	183	225	197.7	55	152	73	17	55		5/16"-18G	4	10
40(1-1/2")	38	110	150	50	PT1-1/2"	18	4	31.0	183	183	232	197.7	55	152	73	19	55		5/16"-18G	4	10
50(2")	48	120	165	63	PT 2"	18	4	37.5	202	202	253	208.3	55	152	85	21	68		5/16"-18G	4	10
65(2-1/2")	65	145	185	75	PT2-1/2"	18	4	43.5	228	228	282	263.2	68	230	98	21	80	41	5/16"-18G	8	7
80(3")	78	160	200	90	PT 3"	18	8	51.0	270	270	327	307.7	85	271	110	22	80	41	5/16"-18G	8	7
100(4")	102	180	220	110	PT 4"	18	8	61.0	324	324	385	326.0	80	360	14	22	121	50	5/16"-18G	8	7